

● **STEFANIA XF115-B**

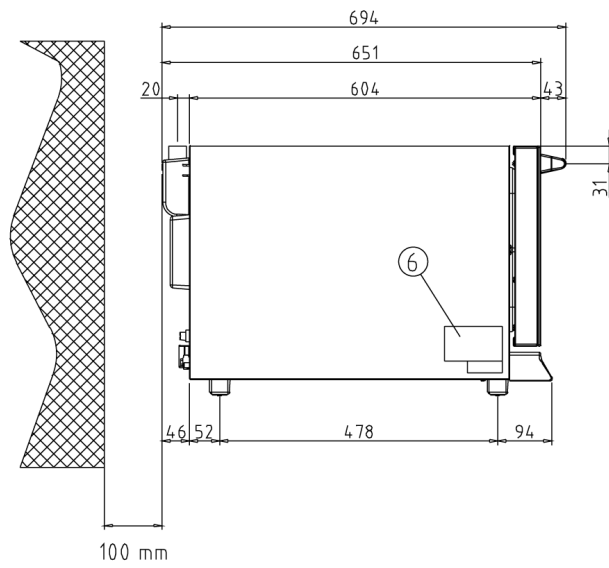

STEFANIA	XF115-B
Kapazität	3 460x330
Abstand	75 mm
Frequenz	50 / 60 Hz
Spannung	230 V~ 1N
Anschlusswert	3 kW
Abmessungen	600x429x650 mm
Gewicht	25 kg

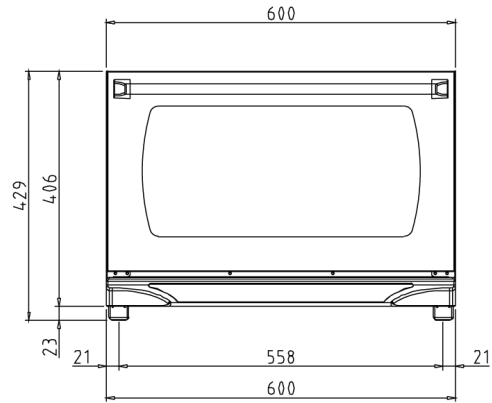
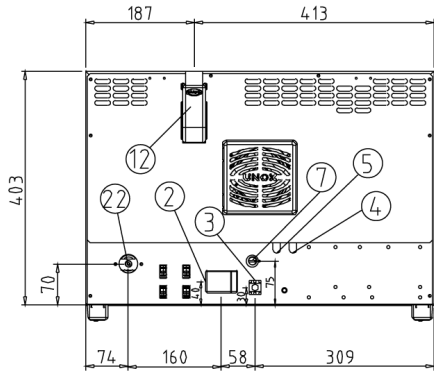

	MATIC	DYNAMIC	CLASSIC	MANUAL HUM.
BAKING MODES				
Convection baking 30 °C - 260 °C	•	•	•	•
Mixed humidity and convection baking 48 °C - 260 °C	•	•	-	•
AIR DISTRIBUTION IN THE BAKING CHAMBER				
AIR.Maxi™ technology: fans with reversing gear for models 600x400	•	•	•	•
AIR.Maxi™ technology: fans with reversing gear for models 460x330	•	•	•	-
CLIMA MANAGEMENT IN THE BAKING CHAMBER				
DRY.Maxi™ technology: quick extraction of the humidity from the baking chamber	•	•	•	•
STEAM.Maxi™ technology: injection humidity from 20 to 100%, settable from the control panel	•	•	-	-
STEAM.Maxi™ technology: manual injection humidity	-	•	-	•
Pompa che permette al forno di aspirare acqua dal serbatoio (per modelli 460x330)	0	0	0	0
Elettrovalvola che permette di collegare il forno direttamente alla rete idrica (per modelli 600x400)	0	0	0	0
PANS				
Pans aluminium flat (only for models 460x330)	•	•	•	•
AUXILIARIES FUNCTIONS				
70 baking programs memory, each one composed by 3 steps	•	•	-	-
70 baking programs memory, each one composed by 1step	-	-	•	-
Protek.SAFE™ technology: maximum thermal efficiency and working safety (cold door glass and external surfaces)	•	•	•	•
Visualization of the set and real values of time left to finish the baking program	•	•	•	•
Continuous functioning «INF»	•	•	•	•
Visualization of the set and real values of the baking chamber temperature	•	•	•	-
Temperature unit settable in °C or °F	•	•	•	-
DOOR OPENING				
Manual up-to-down door opening	-	•	•	•
Right-to-left door opening	•	-	-	-
Automatic door opening at the end of the baking program	•	-	-	-
TECHNICAL DETAILS				
Rounded baking chamber made of high resistant AISI 304 stainless steel for hygiene and easy of cleaning	•	•	•	•
Rounded baking chamber made of high resistant ferritic steel for hygiene and easy of cleaning	-	-	-	-
Halogen lights	•	•	•	•
Baking chamber lights	-	-	-	-
Light weight – heavy duty structure using innovative materials	•	•	•	•
Proximity door contact switch	•	•	•	-
Autodiagnosys system for problems or brake down	•	•	•	-
Safety temperature switch	•	•	•	•